

SMARTRAIL X835

Din Rail Smart Energy Meter for Single and Three Phase Electrical Systems



Installation and Operation Instructions

Important Safety Information is contained in the Maintenance section. Familiarize yourself with this information before attempting installation or other procedures.

Symbols used in this document:



Risk of Danger: These instructions contain important safety information:
Read them before starting installation or servicing of the equipment



Caution: Risk of Electric Shock

1 Introduction

This document provides operating, maintenance and installation instructions . The unit measures and displays the characteristics of single phase two wires and three phase four wires supplies, including voltage, frequency, current, power and active and reactive energy, imported or exported. Energy is measured in terms of kWh, kVarh. Maximum demand current can be measured over preset periods of up to 60minutes. In order to measure energy, the unit requires voltage and current inputs in addition to the supply required to power the product. The requisite current input(s) are obtained via current transformers (CT).

This meter can be configured to work with a wide range of CTs, giving the unit a wide range of operation. Built-in interfaces provide pulse and RS485 Modbus RTU outputs. Configuration is password protected.

The unit can be powered from a separate auxiliary (AC or DC) supply. Alternatively it can be powered from the monitored supply, where appropriate.

1.1 Unit Characteristics

The Unit can measure and display:

- Line voltage and THD% (total harmonic distortion) of all phases
- Line Frequency
- Currents, Current demands and current THD% of all phases
- Power, maximum power demand and power factor
- Active energy imported and exported
- Reactive energy imported and exported

The unit has password-protected set-up screens for:

- Changing password
- Supply system selection 1phase2wire, 3phase 4wires
- CT Ratio (1 to9999)
- PT ratio (1 to 9999)
- Demand Interval time
- Reset for demand measurements
- Pulse output duration

A pulse output indicates real-time energy measurement. An RS485 output allows remote monitoring from another display or a computer.

1.2 Current Transformer Primary Current

The unit can be configured to operate with CT ratio between Primary Current and Secondary Current. The secondary CT has two options: 1A / 5A

1.3 RS485 Serial – Modbus RTU



This uses an RS485 serial port with Modbus RTU protocol to provide a means of remotely monitoring and controlling the Unit

Set-up screens are provided for setting up the RS485 port. See section 4.8

1.4 Pulse output

This provides 2 pulse outputs that clocks up measured active and reactive energy. The constant for reactive energy is 3200imp/kVarh. The pulse width for active energy can be set from the Set-up menu.

2. Start Up Screens



 <p>The first screen lights all display segments and can be used as a display check</p>	<p>The first screen lights all display segments and can be used as a display check</p>
 <p>The second screen indicates the firmware installed in the unit and its build number.</p>	<p>The second screen indicates the firmware installed in the unit and its build number.</p>
 <p>Next the unit performs a self-test and indicates if the test passes.</p>	<p>Next the unit performs a self-test and indicates if the test passes.</p>

After a short delay, the screen will display active energy measurements.

3. Measurements



The buttons operate as follows:

	<p>Selects the Voltage and Current display screens In Set-up Mode, this is the “Left” or “Back” button.</p>
---	---

	<p>Select the Frequency and Power factor screens In Set-up Mode, this is the “Up” button</p>
	<p>Select the Power screens In Set-up Mode, this is the “Down” button</p>
	<p>Select the Energy display screens In Set-up mode, this is the “Enter” or “Right” button</p>

3.1 Voltage and Current

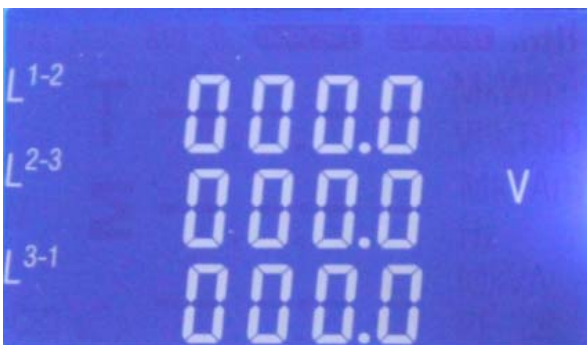
Each successive pressing of the  button selects a new range:

<p>Phase to neutral voltages</p>	
<p>Current on each phase</p>	
<p>Phase to neutral voltage THD%</p>	

Current THD% for each phase







3.2 Frequency and Power factor and demand







Each successive pressing of the



Frequency	
Power factor (total)	
Power factor of each phase	
Active power demand	
Max. Power demand	
Max. Current demand	





3.3 Power 

Each successive pressing of the  button select a new range:

Instantaneous active power kW	
Instantaneous reactive power kVar	
Instantaneous Volt-amps KVA	
Total kW, kVarh, kVA	

3.4 Energy Measurements

Each successive pressing of the  button selects a new range:

Imported active energy in kWh	 <p>The display shows 'IMPORT' at the top. The top row shows '0000 kWh' and the bottom row shows '031.4'.</p>
Exported active energy in kWh	 <p>The display shows 'EXPORT' at the top. The top row shows '0000 kWh' and the bottom row shows '000.0'.</p>
Imported reactive energy in kVarh	 <p>The display shows 'IMPORT' at the top. The top row shows '0000 kVarh' and the bottom row shows '000.3'.</p>
Exported reactive energy in kVarh	 <p>The display shows 'EXPORT' at the top. The top row shows '0000 kVarh' and the bottom row shows '000.0'.</p>
Total active energy in kWh	 <p>The display shows '0000 kWh' on the top row and 'M 031.4' on the bottom row.</p>

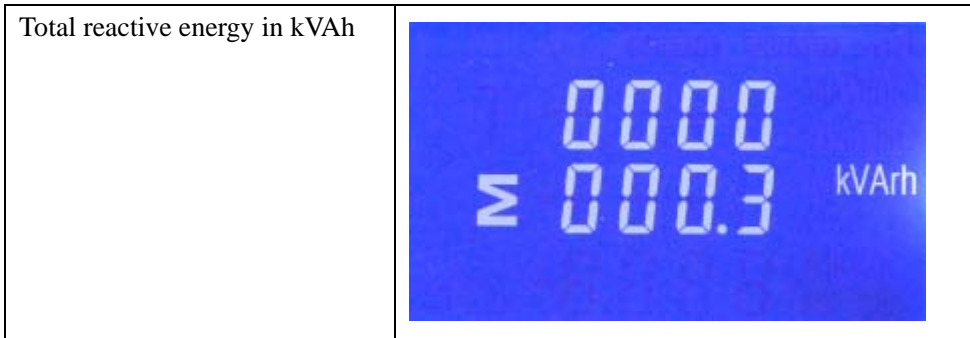

4. Setting Up

To enter set-up mode, pressing the  button for 3 seconds, until the password screen appears.



Setting up is password-protected so you must enter the correct password (default '1000') before processing. If an incorrect password is entered, the display will show: PASS Err

To exit setting-up mode, press  repeatedly until the measurement screen is restored.

4.1 Set-up Menu Structure

Change password

nnnn 4-digit number – default '1000'



CT Set the value of the CT ratio

nnnn 4-digit number 0001~9999.



PT set the value of PT Ratio

Nnnn 4-digit number 000001~500000.





DIT Demand Integration Time

This is the period in minutes over which the current and power readings are integrated for maximum demand measurement. Options are: off, 5 , 10, 15, 30 and 60minutes.

4.2 Set-up Entry Methods

Some menu items, such as password and CT, require a four-digit number entry while others, such as supply system, require selection from a number of menu options.

4.2.1 Menu Option Selection



1. Use the  and  buttons to select the required item from the menu shown in section 4.1. selection does not roll over between bottom and top of list

2. Press  to confirm your selection

3. if an item flashes, then it can be adjusted by the  and  buttons. If not, there maybe a further layer.

4. Having selected an option from the current layer, press  to confirm your selection. The SET indicator will appear.





5. Having completed a parameter setting, press  to return to a higher menu level. The

SET indicator will be removed and you will be able to use the  and  buttons for further menu selection.













6. on completion of all setting-up, press  repeatedly until the measurement screen is restored.

4.2.2 Number Entry Procedure

When Setting up the unit , some screens require the entering of a number. In particular, on entry to the setting up section, a password must be entered. Digits are set individually, from left to right. The procedure is as follows:











1. the current digit to be set flashes and is set using the  and  buttons
2. Press  to confirm each digit setting. The SET indicator appears after the last digit has been set.
3. After setting the last digit, press  to exit the number setting routine. The SET indicator will be removed.

4.3 Change password

1	Use the  and  to choose the change password option	
2	Press the  to enter the change password routine. The new password screen will appear with the first digit flashing	
3	Use  and  to set the first digit and press  to confirm your selection. The next digit will flash.	
4	Repeat the procedure for the remaining three digits	
5	After setting the last digit, SET will show.	
6	Press  to exit the number setting routine and return to the Set-up menu. SET will be removed	



4.4 DIT Demand Integration Time









This sets the period in minutes over which the current and power readings are integrated for maximum demand measurement. The options are: off, 5, 10, 15, 30, 60 minutes

1	<p>From the set-up menu, use  and  buttons to select the dIT option. The screen will show the currently selected integration time.</p>	
2	<p>Press  to enter the selection routine. The current time interval will flash</p>	
3	<p>Use  and  buttons to select the time required.</p>	
4	<p>Press  to confirm the selection. SET indicator will appear.</p>	
5	<p>Press  to exit the dIT selection routine and return to the menu.</p>	

4.5 Supply System



Use this section to set the type of power supply being monitored.





1	<p>From the Set-up menu, use  and  buttons to select the System option. The screen will show the currently selected power supply .</p>	
---	--	--

2	<p>Press  to enter the selection routine. The current selection will flash</p>	
3	<p>Use  and  buttons to select the required system option: 3P4W 3P3W or 1P2W</p>	
4	<p>Press  to confirm the selection. SET indicator will appear.</p>	
5	<p>Press  to exit the system selection routine and return to the menu. SET will disappear and you will be returned to the main Set-up Menu</p>	

4.6 CT





The CT option sets the current ratio (1~9999) and secondary current (CT2 1A or 5A) of the current transformer (CT) that wires to the meter.



1	<p>From the Set-up menu, use  and  buttons to select the CT option. The screen will show the current CT primary current value.</p>	
---	--	--

2.	<p>Secondary CT setting</p> <p>Press  to enter the CT secondary current selection routine. 5A/1A</p>	
3	<p>Set CT Ratio Value</p> <p>Press  to enter the CT Ratio</p> <p>The range is from 0001~9999.</p>	
4	<p>For example: if set the ratio to be 100, that means the primary current is secondary current x100.</p>	

4.7 PT

The PT option sets the primary voltage (PT1 100~500000V) and secondary voltage (PT2 100~500V) of the Voltage transformer (PT) that wires to the meter. The default value is 230V for both primary and secondary voltage.

1	<p>From the Set-up menu, use  and  buttons to select the PT option. The screen will show the voltage PT secondary voltage value.</p>	
2	<p>Secondary PT setting</p> <p>The setting method is same as Primary voltage setting PT1</p> <p>Max PT2 value is 500V</p>	
3	<p>Use the method described in section 4.2.2 to set the 4-digit number for the maximum PT ratio between primary and secondary voltage. (1~9999)</p>	











4.	<p>Set PT Ratio Value</p> <p>Press  to enter the PT Ratio</p> <p>The range is from 0001~9999.</p>	
5.	<p>Press  to exit the system selection routine and return to the menu. SET will disappear and you will be returned to the main Set-up Menu</p>	

4.8 Pulse output

This option allows you to configure the pulse output. The output can be set to provide a pulse for a defined amount of energy active or reactive.

Use this section to set up the relay pulse output—

Units: kWh , kVarh

1	<p>From the Set-up menu, use  and  buttons to select the Pulse output option.</p>	
2	<p>Press  to enter the selection routine. The unit symbol will flash.</p>	
3	<p>Use  and  buttons to choose kWh or kVarh.</p>	
4	<p>On Completion of the entry procedure, press  to confirm the setting and press  to return to the main set up menu.</p>	









4.8.1 Pulse rate

Use this to set the energy represented by each pulse. Rate can be set to 1 pulse per

0.01kWh/0.1kWh/1kWh/10kWh/100kWh.



(It shows 1 impulse = 10kWh/kVarh)



1	From the Set-up menu, use  and  buttons to select the Pulse Rate option.	
2	Press  to enter the selection routine. The current setting will flash.	
3	Use  and  buttons to choose pulse rate.	0.01/0.1/1/10/100kWh/kVarh per pulse
4	On Completion of the entry procedure, press  to confirm the setting and press  to return to the main set up menu.	







4.8.2 Pulse Duration

The energy monitored can be active or reactive and the pulse width can be selected as 200, 100 or 60ms.



(It shows pulse width of 200ms)

1	From the Set-up menu, use  and  buttons to select the Pulse width option.	
---	---	--

2	Press  to enter the selection routine. The current setting will flash.	
3	Use  and  buttons to choose pulse width.	200/100/60ms
4	On Completion of the entry procedure, press  to confirm the setting and press  to return to the main set up menu.	

4.9 Communication

There is a RS485 port can be used for communication using Modbus RTU protocol. For Modbus RTU, parameters are selected from Front panel.

4.9.1 RS485 Address





4.9.2 Baud Rate





1	From the Set-up menu, use  and  buttons to select the Baud Rate option.	
2	Press  to enter the selection routine. The current setting will flash.	
3	Use  and  buttons to choose Baud rate 2.4k, 4.8k, 9.6k, 19.2k, 38.4k	
4	On Completion of the entry procedure, press  to confirm the setting and press  to return to the main set up menu.	

4.9.3 Parity

1	<p>From the Set-up menu, use  and  buttons to select the Parity option.</p>	
2	<p>Press  to enter the selection routine. The current setting will flash.</p>	
3	<p>Use  and  buttons to choose Parity (EVEN / ODD / NONE)</p>	
4	<p>On Completion of the entry procedure, press  to confirm the setting and press  to return to the main set up menu.</p>	







4.9.4 Stop bits

1	<p>From the Set-up menu, use  and  buttons to select the Stop Bit option.</p>	
2	<p>Press  to enter the selection routine. The current setting will flash.</p>	

3	Use  and  buttons to choose Stop Bit (2 or 1)	
4	On Completion of the entry procedure, press  to confirm the setting and press  to return to the main set up menu.	

4.10 CLR

The meter provides a function to reset the maximum demand value of current and power.

1	From the Set-up menu, use  and  buttons to select the reset option.	
2	Press  to enter the selection routine. The dIt will flash.	
3	Press  to confirm the setting and press  to return to the main set up menu.	

5 Specifications

5.1 Measured Parameters

The unit can monitor and display the following parameters of a single phase, 3-phase 3-wire or 3-phase 4-wire supply.

5.1.1 Voltage and Current

Phase to neutral voltages 100 to 289V a.c. (not for 3p3w supplies)

Voltages between phases 173 to 500V a.c. (3p supplies only)

Percentage total voltage harmonic distortion (THD%) for each phase to N (not for 3p3w supplies)

Percentage voltage THD% between phases (three phase supplies only)

Current on each phase – 1 to 9999A range, set by external current transformer(s) (CTs)

Current THD% for each phase

5.1.2 Power factor and Frequency and Max. Demand

Frequency in Hz

Instantaneous power:

Power 0 to 3600 MW

Reactive Power 0 to 3600 MVA_r

Volt-amps 0 to 3600 MVA

Maximum demanded power since last Demand reset Power factor

Maximum neutral demand current, since the last Demand reset (three phase supplies only)

5.1.3 Energy Measurements

Imported active energy 0 to 9999999.9 kWh

Exported active energy 0 to 9999999.9 kWh

Imported reactive energy 0 to 9999999.9 kVA_rh

Exported reactive energy 0 to 9999999.9 kVA_rh

Total active energy 0 to 9999999.9 kWh

Total reactive energy 0 to 9999999.9 kVA_rh

5.2 Measured Inputs

Voltage inputs through 4-way fixed connector with 2.5mm² stranded wire capacity. 3-Phase 3- and 4-wire and Single-phase 2-wire unbalanced. Line frequency measured from L1 voltage or L3 voltage.

Three current inputs (six physical terminals) with 2.5mm² stranded wire capacity for connection of external CTs. Nominal rated input current 5A or 1A a.c. Rms.

5.3 Accuracy

Voltage	0.5% of range maximum
Current	0.5% of nominal
Frequency	0.2% of mid-frequency
Power factor	1% of unity (0.01)
Active power (W)	±1% of range maximum
Reactive power (VA _r)	±2% of range maximum
Apparent power (VA)	±1% of range maximum
Active energy (Wh)	Class 1 IEC 62053-21
Reactive energy (VA _r h)	±2% of range maximum
Total harmonic distortion	1% up to 31st harmonic
Temperature co-efficient	Voltage and current = 0.013%/°C typical Active energy = 0.018%/°C, typical
Response time to step input	1s, typical, to >99% of final reading, at 50 Hz.

5.4 Auxiliary Supply

Two-way fixed connector with 2.5mm² stranded wire capacity.

85 to 275V a.c. 50/60Hz ±10% or 120V to 380V d.c. ±20%. Consumption < 10W.

5.5 Interfaces for External Monitoring

Three interfaces are provided:

- an RS-485 communication channel that can be programmed for Modbus RTU protocol
- an relay output indicating real-time measured energy.(configurable)
- an pulse output 3200imp/kWh (not configurable)

The Modbus configuration (Baud rate etc.) and the pulse relay output assignments (kW/kVArh, import/export etc.) are configured through the Set-up screens.

5.5.1 Pulse Relay Output

The pulse relay output can be set to generate pulses to represent kWh or kVArh.

Rate can be set to generate 1 pulse per:

0.01 = 10 Wh/VArh

0.1 = 100 Wh/VArh

1 = 1 kWh/kVArh

10 = 10 kWh/kVArh

100 = 100 kWh/kVArh

Pulse width 200/100/60 ms.

Relay Rating 240V ac 50mA

5.5.2 RS485 Output for Modbus RTU

For Modbus RTU, the following RS485 communication parameters can be configured from the Set-up menu:

Baud rate 2400, 4800, , 9600, , 19200, 38400

Parity none/odd/even

Stop bits 1 or 2

RS485 network address *nnn* – 3-digit number, 1 to 247

Modbus™ Word order Hi/Lo byte order is set automatically to normal or reverse. It cannot be configured from the set-up menu.

5.6 Reference Conditions of Influence Quantities

Influence Quantities are variables that affect measurement errors to a minor degree. Accuracy is verified under nominal value (within the specified tolerance) of these conditions.

Ambient temperature	23°C ±1°C
Input waveform	50 or 60Hz ±2%
Input waveform	Sinusoidal (distortion factor < 0.005)
Auxiliary supply voltage	Nominal ±1%
Auxiliary supply frequency	Nominal ±1%
Auxiliary supply waveform (if AC)	Sinusoidal (distortion factor < 0.05)
Magnetic field of external origin	Terrestrial flux

5.7 Environment

Operating temperature -25°C to +55°C*

Storage temperature -40°C to +70°C*

Relative humidity	0 to 90%, non-condensing
Altitude	Up to 2000m
Warm up time	1 minute
Vibration	10Hz to 50Hz, IEC 60068-2-6, 2g
Shock	30g in 3 planes

*Maximum operating and storage temperatures are in the context of typical daily and seasonal variation.

5.8 Mechanics

DIN rail dimensions	72 x 94.5 mm (WxH) per DIN 43880
Mounting	DIN rail (DIN 43880)
Sealing	IP20 (minimum)
Material	Self-extinguishing UL 94 V-0

6 Case Dimensions

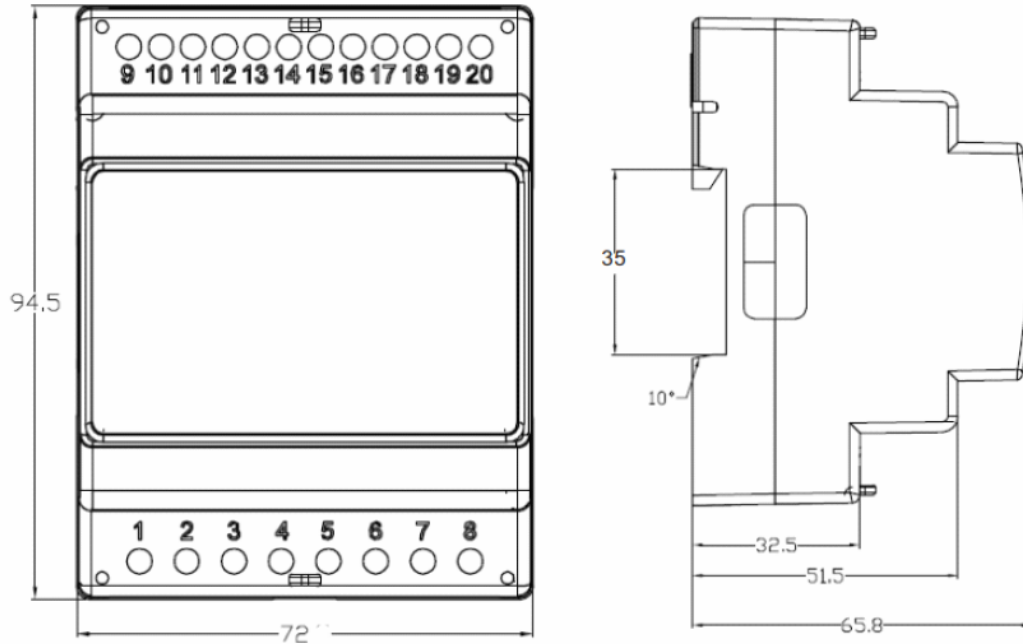

7. Installation

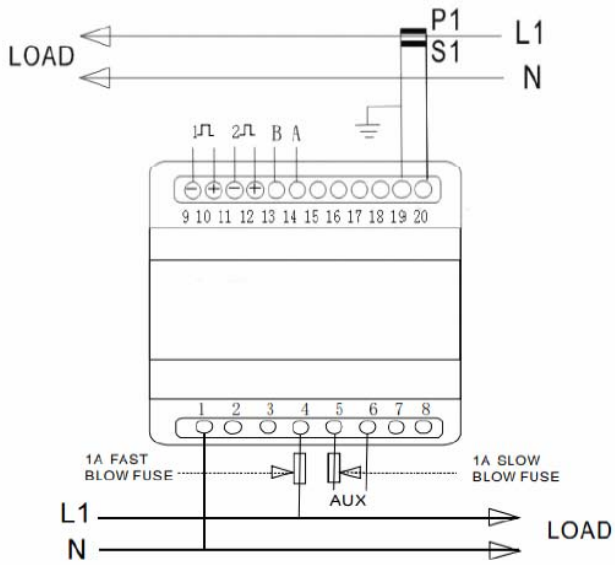

(single phase two wire)

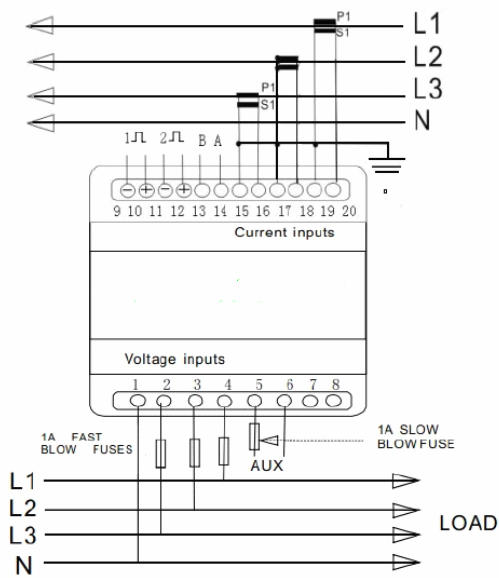

(Three phase four wires)

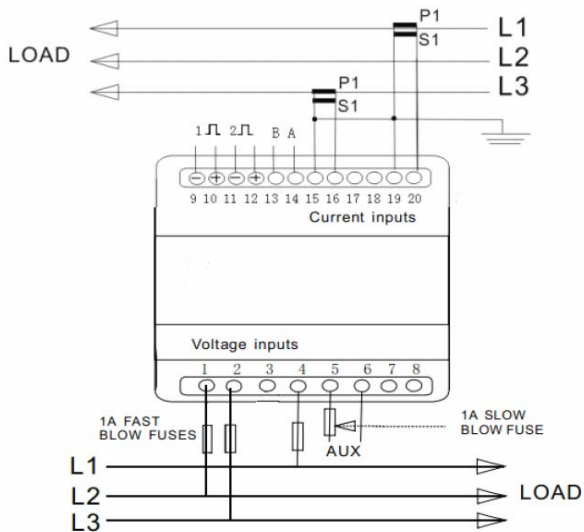

(three phase three wires)

Smart Process & Control Ltd
40 High Street, Canvey
Essex, SS8 7SE
Company registration: 7959147
Telephone: 01268 680088
Fax: 01268 511510
sales@smartprocess.co.uk